

Feedthru 0805/1206 Tin/Lead Capacitors



L2F/L3F Series

GENERAL DESCRIPTION

Available in both a standard 0805 and 1206 size, AVX's line of feedthru capacitors are ideal choices for EMI suppression, broadband I/O filtering, or Vcc power line conditioning. The unique construction of a feedthru capacitor provides low parallel inductance and offers excellent decoupling capability for all high di/dt environments and provides significant noise reduction in digital circuits to <5 GHz. A large range of capacitor values are available in either NP0 or X7R ceramic dielectrics.

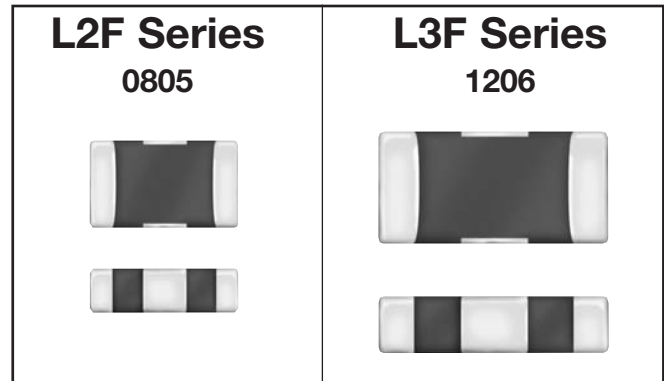
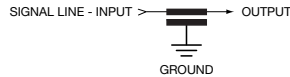

CAPACITOR VALUES

Part Number	Size	Voltage	Dielectric	Capacitance
L2F11A 220 8ATxx	0805	100V	NP0	22pF
L2F11A 470 8ATxx	0805	100V	NP0	47pF
L2F11A 101 8ATxx	0805	100V	NP0	100pF
L2F11A 221 8ATxx	0805	100V	NP0	220pF
L2F11A 471 8ATxx	0805	100V	NP0	470pF
L2F15C 102 8ATxx	0805	50V	X7R	1000pF
L2F15C 222 8ATxx	0805	50V	X7R	2200pF
L2F15C 472 8ATxx	0805	50V	X7R	4700pF
L2F15C 103 8ATxx	0805	50V	X7R	10000pF
L2F15C 223 8ATxx	0805	50V	X7R	22000pF
L2F15C 473 8ATxx	0805	50V	X7R	47000pF
L3F11A 220 8ATxx	1206	100V	NP0	22pF
L3F11A 470 8ATxx	1206	100V	NP0	47pF
L3F11A 101 8ATxx	1206	100V	NP0	100pF
L3F11A 221 8ATxx	1206	100V	NP0	220pF
L3F11A 471 8ATxx	1206	100V	NP0	470pF
L3F15C 102 8ATxx	1206	50V	X7R	1000pF
L3F15C 222 8ATxx	1206	50V	X7R	2200pF
L3F15C 472 8ATxx	1206	50V	X7R	4700pF
L3F15C 103 8ATxx	1206	50V	X7R	10000pF
L3F15C 223 8ATxx	1206	50V	X7R	22000pF
W3F15C 473 8ATxx	1206	50V	X7R	47000pF

PERFORMANCE CHARACTERISTICS

	NP0	X7R
Capacitance Tolerance	+50%, -20%	+50%, -20%
Voltage Rating	100V	50V
Current Rating	300mA	300mA
Insulation Resistance	1000MΩ	1000MΩ
DC Resistance	<0.6Ω	<0.6Ω
Operating Temperature Range	-55 to +125°C	

HOW TO ORDER

L	3	F	1	5	C	223	8	A	B	3	A
Style	Size	Feedthru	Number of Elements	Voltage*	Dielectric	Capacitance Code	Capacitance Tolerance	Failure Rate	Terminations	Packaging Code (Reel Size)	Quantity Code (Pcs./Reel)
	2=0805 3=1206			1=100v 5=50v	A=NP0 C=X7R		8=+50/-20%	A=Not Applicable	B=Tin/Lead min 4%	1=7" Reel Embossed Tape 3=13" Reel Embossed Tape	F=1,000 A=2,000, 4,000 or 10,000

*Note: NP0 available in 100V only and X7R available in 50V only.



Feedthru 0805/1206 Tin/Lead Capacitors



L2F/L3F Series

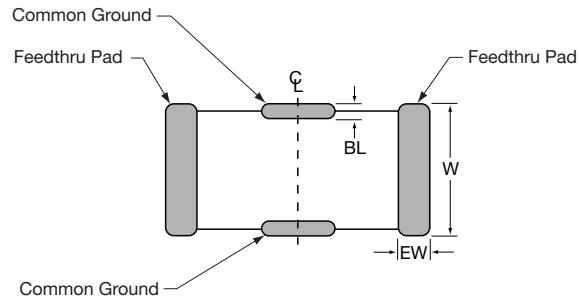
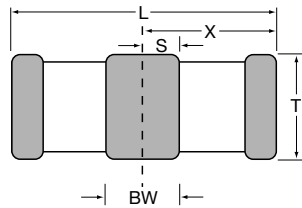

DIMENSIONS

	L	W	T	BW	BL	EW	X	S
0805 MM (in.)	2.01 ± 0.20 (0.079 ± 0.008)	1.25 ± 0.20 (0.049 ± 0.008)	1.14 Max. (0.045 Max.)	0.46 ± 0.10 (0.018 ± 0.004)	0.18 + 0.25 - 0.08 (0.007 + 0.010 - 0.003)	0.25 ± 0.13 (0.010 ± 0.005)	1.02 ± 0.10 (0.040 ± 0.004)	0.23 ± 0.15 (0.009 ± 0.006)
1206 MM (in.)	3.20 ± 0.20 (0.126 ± 0.008)	1.60 ± 0.20 (0.063 ± 0.008)	1.27 Max. (0.050 Max.)	0.89 ± 0.10 (0.035 ± 0.004)	0.18 + 0.25 - 0.08 (0.007 + 0.010 - 0.003)	0.38 ± 0.18 (0.015 ± 0.007)	1.60 ± 0.10 (0.063 ± 0.004)	0.46 ± 0.15 (0.018 ± 0.006)

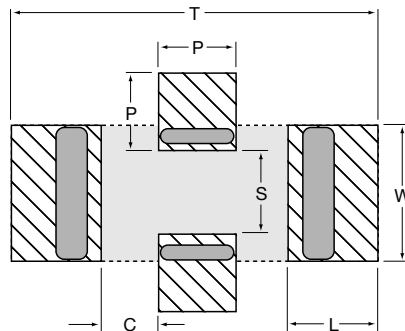

RECOMMENDED SOLDER PAD LAYOUT (TYPICAL DIMENSIONS)

	T	P	S	W	L	C
0805 MM (in.)	3.45 (0.136)	0.51 (0.020)	0.76 (0.030)	1.27 (0.050)	1.02 (0.040)	0.46 (0.018)
1206 MM (in.)	4.54 (0.179)	0.94 (0.037)	1.02 (0.040)	1.65 (0.065)	1.09 (0.043)	0.71 (0.028)

TYPICAL FEEDTHRU CHIP CAP CONNECTION

Feedthru Chip Component Model

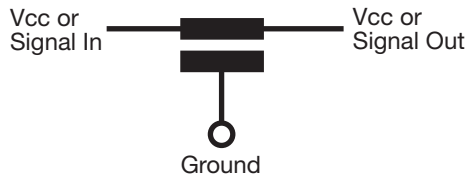

Physical Layout - A

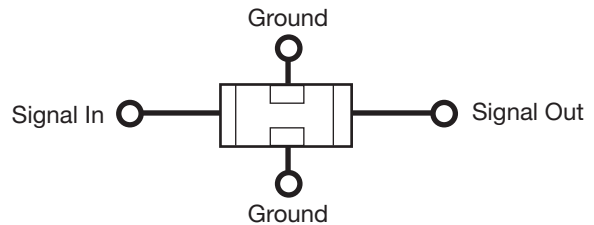

Physical Layout - B

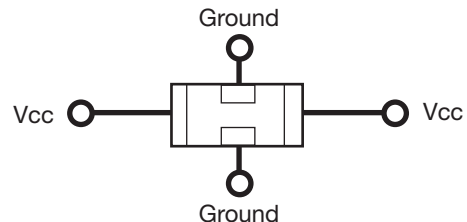

The terminals are connected internally side to side. Left side and right side are connected and front and back are connected internally. For Decoupling, the chip is usually surrounded by four vias, two for Vcc and two for GND. For Signal Filtering, the in and out lines need to be separated on the circuit board.