

WIRE WOUND CHIP INDUCTOR

LCWC Series

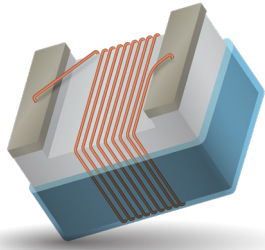

APPLICATIONS

RF Products:

- Cellular Phone (CDMA/GSM/PHS)
- Cordless Phone (DECT/CT1CT2)
- Remote Control, Security System
- Wireless PDA
- Smart Phone
- WLL, Wireless LAN / Mouse / Keyboard / Earphone
- VCO, RF Module & Other Wireless Products
- Base Station, Repeater
- GPS Receiver

Broad Band Applications:

- CATV Filter, Tuner
- Cable Modem/ XDSL Tuner
- Set Top Box

IT Applications:

- USB 2.0
- IEEE 1394

FEATURES

- Ceramic base provides high SRF
- Ultra-compact inductors provide high Q factors
- Miniature SMD chip inductor for fully automated assembly
- Outstanding endurance from Pull-up force, mechanical shock and pressure
- Tighter tolerance down to $\pm 2\%$
- -40°C to $+125^{\circ}\text{C}$

DIMENSIONS

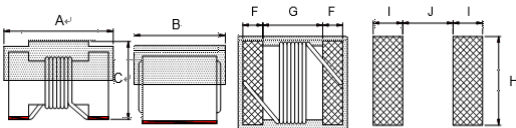

CONSTRUCTION

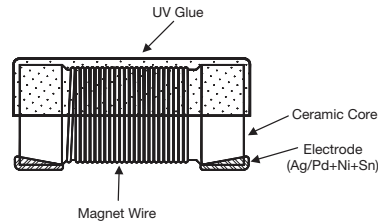

COLOR CODING

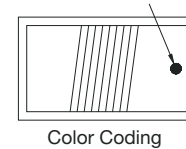

Standard

mm

Type	Size	A Max.	B Max.	C Max.	F	G	H	I	J	Weight (g) (1000pcs)
LCWC 0402	0402	1.19	0.66	0.64	0.23	0.56	0.66	0.36	0.46	0.84
LCWC 0603	0603	1.80	1.02	1.12	0.33	0.86	1.02	0.64	0.64	3.13
LCWC 0805	0805	2.29	1.52	1.73	0.51	1.02	1.78	1.02	0.76	10.42
LCWC 1008	1008	2.92	2.10	2.79	0.51	1.52	2.54	1.27	1.27	33.40
LCWC 1210	1210	3.42	2.30	2.80	0.50	2.05	2.20	1.02	1.78	43.30
LCWC 1812	1812	4.95	3.43	3.81	0.64	3.25	3.05	1.14	3.00	137.50

HOW TO ORDER

LC	WC	0402	K	101	G	T	A	R
Family	Series	Size	Tolerance	Inductance	Style	Termination	Special	Packaging
LC = Chip Inductor	WC = Wire Wound Ceramic	0402 0603 0805 1008 1210 1812	G = 2% J = 5% K = 10% W = ± 0.5 U = ± 0.2 Z = ± 0.1	3N9 = 3.9nH 39N = 39nH R39 = 390nH 3R9 = 3900nH 153 = 15000nH	G = Standard	T = Sn Plating	A = Standard	R = 7" Reel

WIRE WOUND CHIP INDUCTOR

LCWC Series



STANDARD ELECTRICAL SPECIFICATIONS

0402

Inductance (nH)	Tolerance	L Freq. (MHz)	Quality Factor Min.	SRF (GHz)	DCR (Ω) max.	IDC (mA) max.	900MHz		1.7GHz	
							L	Q	L	Q
1	±0.5nH, ±0.2nH, ±0.1nH	250	16	12.7	0.045	1360	1.02	75	1.02	70
1.2	±0.5nH, ±0.2nH, ±0.1nH	250	16	12.9	0.09	740	1.17	30	1.17	40
1.8	±0.5nH, ±0.2nH, ±0.1nH	250	16	12	0.07	1040	2.08	59	1.94	74
1.9	±0.5nH, ±0.2nH, ±0.1nH	250	16	11.3	0.07	1040	1.72	65	1.74	80
2	±0.5nH, ±0.2nH, ±0.1nH	250	16	11.1	0.07	1040	1.93	54	1.93	75
2.2	±0.5nH, ±0.2nH, ±0.1nH	250	19	10.8	0.07	960	2.19	55	2.23	82
2.4	±0.5nH, ±0.2nH, ±0.1nH	250	15	10.5	0.068	790	2.24	51	2.27	70
2.5	±0.5nH, ±0.2nH, ±0.1nH	250	15	10.4	0.15	660	2.37	33	2.38	53
2.7	±0.5nH, ±0.2nH, ±0.1nH	250	16	10.4	0.12	640	2.58	42	2.6	61
3.3	±0.5nH, ±0.2nH, ±0.1nH	250	19	7	0.066	840	3.1	65	3.12	80
3.6	±0.5nH, ±0.2nH, ±0.1nH	250	19	6.8	0.066	840	3.56	45	3.62	71
3.9	±0.5nH, ±0.2nH, ±0.1nH	250	19	6	0.066	840	3.89	50	4.14	72
4.1	±0.5nH, ±0.2nH, ±0.1nH	250	18	6	0.066	700	3.89	50	4.14	72
4.3	±0.5nH, ±0.2nH, ±0.1nH	250	18	6	0.091	700	4.19	40	4.3	71
4.7	±0.5nH, ±0.2nH, ±0.1nH	250	15	4.7	0.13	640	4.78	47	4.59	62
5.1	±0.5nH, ±0.2nH, ±0.1nH	250	20	4.8	0.083	800	5.16	52	5.19	76
5.6	2%, 5%, 10%	250	20	4.8	0.083	760	5.2	48	5.28	75
5.8	2%, 5%, 10%	250	20	4.8	0.083	760	5.6	48	5.63	74
6.2	2%, 5%, 10%	250	20	4.8	0.083	760	6.15	50	6.2	73
6.8	2%, 5%, 10%	250	20	4.8	0.083	680	6.73	65	6.95	70
7.3	2%, 5%, 10%	250	20	4.8	0.1	680	7.51	60	7.89	80
7.5	2%, 5%, 10%	250	22	4.8	0.1	680	7.91	60	8.22	85
8.2	2%, 5%, 10%	250	22	4.4	0.1	680	8.53	64	8.81	88
8.7	2%, 5%, 10%	250	18	4.1	0.2	480	8.78	54	9.21	73
9	2%, 5%, 10%	250	22	4.16	0.1	680	9.07	65	9.53	83
9.1	2%, 5%, 10%	250	22	4.16	0.1	680	9.27	63	8.61	73
9.5	2%, 5%, 10%	250	18	4	0.2	480	9.64	62	9.93	56
10	2%, 5%, 10%	250	21	3.9	0.2	480	10.16	50	9.72	85
11	2%, 5%, 10%	250	24	3.68	0.12	640	10.89	53	11.46	77
12	2%, 5%, 10%	250	24	3.6	0.12	640	12.71	62	12.87	77
13	2%, 5%, 10%	250	24	3.45	0.21	440	13.4	51	14.63	57
15	2%, 5%, 10%	250	24	3.28	0.17	560	15.2	55	16.88	76
16	2%, 5%, 10%	250	24	3.1	0.22	560	16.43	45	18.79	49
18	2%, 5%, 10%	250	25	3.1	0.23	420	17.39	52	22.18	64
19	2%, 5%, 10%	250	24	3.04	0.2	480	19.51	60	21.85	72
20	2%, 5%, 10%	250	25	3	0.25	420	20.7	52	23.66	53
22	2%, 5%, 10%	250	25	2.8	0.3	400	22.33	57	26.54	53
23	2%, 5%, 10%	250	22	2.72	0.3	400	23.8	49	26.85	64
24	2%, 5%, 10%	250	25	2.7	0.3	400	25.59	59	31.06	56
27	2%, 5%, 10%	250	24	2.48	0.3	400	29.26	45	32.56	62
30	2%, 5%, 10%	250	25	2.35	0.3	400	31.9	45	40.38	41
33	2%, 5%, 10%	250	24	2.35	0.44	400	34.12	35	40.32	36
36	2%, 5%, 10%	250	24	2.32	0.44	320	39.5	45	48.4	53
39	2%, 5%, 10%	250	25	2.1	0.55	200	42.65	45	50.96	42
40	2%, 5%, 10%	250	24	2.24	0.44	320	39	44	47.41	35
43	2%, 5%, 10%	250	25	2.03	0.81	100	45.8	46	61.55	35
47	2%, 5%, 10%	250	20	2.1	0.83	150	52.85	42	-	-
51	2%, 5%, 10%	250	25	1.75	0.82	100	56.6	40	-	-
56	2%, 5%, 10%	250	22	1.76	0.97	100	58.59	40	-	-
57	2%, 5%, 10%	250	22	1.76	0.97	100	60.15	40	-	-
62	2%, 5%, 10%	250	22	1.76	1.62	100	64.95	40	-	-
68	2%, 5%, 10%	250	22	1.62	1.12	100	72.17	40	-	-
72	2%, 5%, 10%	250	20	1.26	2	30	-	-	-	-
75	2%, 5%, 10%	250	20	1.62	2	50	-	-	-	-
82	2%, 5%, 10%	250	20	1.26	1.55	50	-	-	-	-
91	2%, 5%, 10%	250	22	1.26	2	50	-	-	-	-
100	2%, 5%, 10%	250	20	1.16	2	30	-	-	-	-
120	2%, 5%, 10%	250	20	1.9	2.2	50	-	-	-	-

WIRE WOUND CHIP INDUCTOR

LCWC Series



0603

Inductance (nH)	Tolerance	L Freq. (MHz)	Quality Factor Min.	SRF (GHz)	DCR (Ω) max.	IDC (mA) max.	Color Code
1.6	5%, 10%	250	24	12500	0.03	700	Black
1.8	5%, 10%	250	16	12500	0.045	700	Brown
2.1	5%, 10%	250	20	5800	0.05	700	Red
2.2	5%, 10%	250	20	5800	0.1	700	Orange
3.3	5%, 10%	250	20	5500	0.07	700	Violet
3.6	5%, 10%	250	22	5900	0.063	700	Red
3.9	5%, 10%	250	22	6900	0.08	700	Orange
4.3	5%, 10%	250	22	5900	0.063	700	Yellow
4.7	5%, 10%	250	20	5800	0.116	700	Green
5.1	5%, 10%	250	20	5700	0.14	700	Blue
5.6	5%, 10%	250	15	5800	0.15	700	Gray
6.1	5%, 10%	250	25	5800	0.11	700	White
6.3	2%, 5%	250	25	5800	0.11	700	Gray
6.8	2%, 5%, 10%	250	27	5800	0.11	700	Violet
7.2	2%, 5%, 10%	250	28	4800	0.106	700	Black
7.5	2%, 5%, 10%	250	28	4800	0.106	700	Gray
8.2	2%, 5%, 10%	250	25	5800	0.12	700	Black
8.4	2%, 5%, 10%	250	28	4600	0.109	700	Red
8.5	2%, 5%, 10%	250	28	4600	0.109	700	Red
8.7	2%, 5%	250	28	4600	0.109	700	White
9.5	2%, 5%	250	28	5400	0.135	700	Black
10	2%, 5%	250	31	4800	0.13	700	Brown
11	2%, 5%	250	33	4000	0.086	700	Red
12	2%, 5%	250	35	4000	0.13	700	Orange
13	2%, 5%	250	35	4000	0.15	700	Yellow
14	2%, 5%	250	35	4000	0.17	700	Brown
15	2%, 5%	250	35	4000	0.17	700	Yellow
16	2%, 5%	250	34	3300	0.104	700	Green
18	2%, 5%	250	35	3100	0.17	700	Blue
20	2%, 5%	250	40	3000	0.19	700	Green
22	2%, 5%	250	38	3000	0.19	700	Violet
24	2%, 5%	250	37	2650	0.135	700	Gray
27	2%, 5%	250	40	2800	0.22	600	White
30	2%, 5%	250	37	2250	0.22	600	Black
33	2%, 5%	250	40	2300	0.22	600	Brown
36	2%, 5%	250	38	2080	0.25	600	Red
39	2%, 5%	250	40	2200	0.25	600	Orange
43	2%, 5%	250	39	2000	0.28	600	Yellow
47	2%, 5%	200	38	2000	0.28	600	Green
56	2%, 5%	200	38	1900	0.31	600	Blue
62	2%, 5%	200	37	1800	0.34	600	Gray
68	2%, 5%	200	37	1700	0.34	600	Violet
72	2%, 5%	150	34	1700	0.49	400	Gray
75	2%, 5%	150	34	1700	0.52	400	Blue
82	2%, 5%	150	34	1700	0.54	400	White
91	2%, 5%	150	30	1700	0.5	400	Blue
100	2%, 5%	150	34	1400	0.58	400	Black
110	2%, 5%	150	32	1350	0.61	300	Brown
120	2%, 5%	150	32	1300	0.65	300	Red
130	2%, 5%	150	30	1400	0.72	300	White
150	2%, 5%	100	28	990	0.92	280	Orange
180	2%, 5%	100	25	990	1.25	240	Yellow
200	2%, 5%	100	25	990	1.98	200	Red
220	2%, 5%	100	25	900	1.9	200	Green
260	2%, 5%	100	25	1000	2	200	Violet
270	2%, 5%	100	24	900	2.3	170	Blue
330	2%, 5%	100	24	900	3.9	185	Violet
390	2%, 5%	100	25	900	4.35	100	Gray
430	2%, 5%	100	25	800	4.5	100	Green
470	2%, 5%	100	25	600	3.6	80	White
680	5%	100	25	500	6.3	60	Black



The Important Information/Disclaimer is incorporated in the catalog where these specifications came from or available online at www.avx.com/disclaimer/ by reference and should be reviewed in full before placing any order.

WIRE WOUND CHIP INDUCTOR

LCWC Series



0805

Inductance (nH)	Tolerance	L Freq. (MHz)	Quality Factor Min.	SRF (GHz) min	DCR (Ω) max.	IDC (mA) max.	Color Code
2.2	5%, 10%	250	35	3000	0.08	600	White
2.7	5%, 10%	250	80	7900	0.03	600	Brown
2.8	5%, 10%	250	80	7900	0.06	800	Red
2.9	5%, 10%	250	50	4700	0.05	600	Blue
3	5%, 10%	250	65	7900	0.06	800	Violet
3.3	5%, 10%	250	35	7900	0.08	600	Black
5.6	5%, 10%	250	65	5500	0.08	600	Violet
6.8	5%, 10%	250	50	5500	0.11	600	Brown
7.5	5%, 10%	250	50	4500	0.1	600	Black
8.2	2%, 5%, 10%	250	50	4700	0.12	600	Red
8.7	2%, 5%, 10%	250	50	4700	0.1	400	White
10	2%, 5%, 10%	250	60	4200	0.1	600	Red
12	2%, 5%, 10%	250	50	4000	0.15	600	Orange
15	2%, 5%, 10%	250	50	3400	0.17	600	Yellow
18	2%, 5%, 10%	250	50	3300	0.2	600	Green
22	2%, 5%, 10%	250	55	2600	0.22	500	Blue
24	2%, 5%, 10%	250	50	2000	0.22	500	Red
27	2%, 5%, 10%	250	55	2500	0.25	500	Violet
33	2%, 5%, 10%	250	60	2050	0.27	500	Gray
36	2%, 5%, 10%	250	55	1700	0.27	500	Yellow
39	2%, 5%, 10%	250	60	2000	0.29	500	White
43	2%, 5%, 10%	200	60	1650	0.34	500	Yellow
47	2%, 5%, 10%	200	60	1650	0.31	500	Black
56	2%, 5%, 10%	200	60	1550	0.34	500	Brown
68	2%, 5%, 10%	200	60	1450	0.38	500	Red
82	2%, 5%, 10%	150	65	1300	0.42	400	Orange
91	2%, 5%, 10%	150	65	1200	0.48	400	Blue
100	2%, 5%, 10%	150	65	1200	0.46	400	Yellow
110	2%, 5%, 10%	150	50	1000	0.48	400	Violet
120	2%, 5%, 10%	150	50	1100	0.51	400	Green
150	2%, 5%, 10%	100	50	920	0.56	400	Blue
160	2%, 5%, 10%	100	50	900	0.6	400	Yellow
180	2%, 5%, 10%	100	50	870	0.64	400	Violet
200	2%, 5%, 10%	100	50	860	0.68	400	Red
220	2%, 5%, 10%	100	50	850	0.7	400	Gray
240	2%, 5%, 10%	100	44	690	1	350	Black
250	2%, 5%, 10%	100	50	680	1	350	Yellow
270	2%, 5%, 10%	100	48	650	1.15	350	White
300	2%, 5%, 10%	100	48	620	1.2	300	Gray
330	2%, 5%, 10%	100	48	600	1.4	300	Black
360	2%, 5%, 10%	100	35	400	0.9	300	Orange
390	2%, 5%, 10%	100	48	560	1.5	300	Brown
430	2%, 5%, 10%	100	33	430	1.7	190	White
470	5%, 10%	50	33	375	1.7	250	Violet
560	5%, 10%	25	23	340	1.9	230	Orange
620	5%, 10%	25	23	200	2	190	Orange
680	5%, 10%	25	23	188	2.2	190	Green
820	5%, 10%	25	23	215	2.5	190	Brown
910	5%, 10%	25	24	250	2.3	170	Red
1000	10%, 5%	25	23	100	2.7	170	Black
2200	2%, 5%	7.9	16	60	2.7	160	Red

WIRE WOUND CHIP INDUCTOR

LCWC Series



1008

Inductance (nH)	Tolerance	L Freq. (MHz)	Quality Factor Min.	SRF (GHz)	DCR (Ω) max.	IDC (mA) max.	Color Code		
							1st	2nd	Multiplier
8.2	5%	50	50	4100	0.08	1000	Gray	Red	Black
10	5%, 10%	50	50	4100	0.08	1000	Brown	Black	Black
12	5%, 10%	50	50	3300	0.09	1000	Brown	Red	Black
15	5%, 10%	50	50	2500	0.1	1000	Brown	Green	Black
18	2%, 5%, 10%	50	50	2500	0.11	1000	Brown	Gray	Black
22	2%, 5%, 10%	50	55	2400	0.12	1000	Red	Red	Black
24	2%, 5%, 10%	50	50	1900	0.13	1000	Red	Yellow	Black
27	2%, 5%, 10%	50	55	1600	0.13	1000	Red	Violet	Black
33	2%, 5%, 10%	50	60	1600	0.14	1000	Orange	Orange	Black
36	2%, 5%, 10%	50	60	1600	0.15	1000	Orange	Blue	Black
39	2%, 5%, 10%	50	60	1500	0.15	1000	Orange	White	Black
47	2%, 5%, 10%	50	65	1500	0.16	1000	Yellow	Violet	Black
56	2%, 5%, 10%	50	65	1300	0.18	1000	Green	Blue	Black
68	2%, 5%, 10%	50	65	1300	0.2	1000	Blue	Gray	Black
82	2%, 5%, 10%	50	60	1000	0.22	1000	Gray	Red	Black
100	2%, 5%, 10%	25	60	1000	0.56	650	Brown	Black	Brown
120	2%, 5%, 10%	25	60	950	0.63	650	Brown	Red	Brown
150	2%, 5%, 10%	25	45	850	0.7	580	Brown	Green	Brown
180	2%, 5%, 10%	25	45	750	0.77	620	Brown	Gray	Brown
200	2%, 5%, 10%	25	50	750	0.81	500	Red	Black	Brown
220	2%, 5%, 10%	25	45	700	0.84	500	Red	Red	Brown
240	2%, 5%, 10%	25	50	650	0.84	500	Red	Yellow	Brown
270	2%, 5%, 10%	25	45	600	0.91	500	Red	Violet	Brown
300	2%, 5%, 10%	25	45	585	1.05	660	Orange	Black	Brown
330	2%, 5%, 10%	25	45	570	1.05	450	Orange	Orange	Brown
360	2%, 5%, 10%	25	45	530	1.05	660	Orange	Blue	Brown
390	2%, 5%, 10%	25	45	500	1.12	470	Orange	White	Brown
430	2%, 5%, 10%	25	45	480	1.19	600	Yellow	Orange	Brown
470	2%, 5%, 10%	25	45	450	1.19	470	Yellow	Violet	Brown
560	2%, 5%, 10%	25	45	415	1.33	400	Green	Blue	Brown
620	2%, 5%, 10%	25	45	375	1.4	300	Blue	Red	Brown
680	2%, 5%, 10%	25	45	375	1.47	400	Blue	Gray	Brown
750	2%, 5%, 10%	25	45	360	1.54	360	Violet	Green	Brown
820	2%, 5%, 10%	25	45	350	1.61	400	Gray	Red	Brown
910	2%, 5%, 10%	25	35	320	1.68	380	White	Brown	Brown
1000	2%, 5%, 10%	25	35	290	1.75	370	Brown	Black	Red
1200	2%, 5%, 10%	7.9	35	250	2	310	Brown	Red	Red
1500	2%, 5%, 10%	7.9	28	200	2.3	330	Brown	Green	Red
1800	2%, 5%, 10%	7.9	28	160	2.6	300	Brown	Gray	Red
2000	2%, 5%, 10%	7.9	25	160	2.8	280	Red	Black	Red
2200	2%, 5%, 10%	7.9	28	160	2.8	280	Red	Red	Red
2700	2%, 5%, 10%	7.9	22	140	3.2	290	Red	Violet	Red
3300	2%, 5%, 10%	7.9	22	110	3.4	290	Orange	Orange	Red
3900	2%, 5%, 10%	7.9	20	100	3.6	260	Orange	White	Red
4700	2%, 5%, 10%	7.9	20	90	4	260	Yellow	Violet	Red
5600	5%, 10%	7.9	16	20	4.5	240	Green	Blue	Red
8200	2%, 5%, 10%	7.9	15	25	6	170	Gray	Red	Red
10000	5%, 10%	2.52	15	20	9	150	Brown	Black	Orange
12000	5%, 10%	2.52	15	18	10.5	130	Brown	Red	Orange
15000	5%, 10%	2.52	15	15	11.5	120	Brown	Green	Orange



The Important Information/Disclaimer is incorporated in the catalog where these specifications came from or available online at www.avx.com/disclaimer/ by reference and should be reviewed in full before placing any order.

WIRE WOUND CHIP INDUCTOR

LCWC Series



1210

Inductance (nH)	Test Freq. (MHz)	Inductance Tolerance	Q Min	Test Freq. (MHz)	SRF (MHz) Min	DCR (OHM) Max	Irms (mA)	COLOR CODE		
								1st	2nd	multiplier
4.7	100	5%, 10%	50	1000	6000	0.06	600	Yellow	Violet	Black
5.6	100	5%, 10%	50	1000	5500	0.08	600	Green	Blue	Black
10	100	2%, 5%, 10%	60	500	4000	0.06	600	Brown	Black	Brown
12	100	2%, 5%, 10%	60	500	3400	0.06	600	Brown	Red	Brown
15	100	2%, 5%, 10%	60	500	3200	0.06	600	Brown	Green	Brown
18	100	2%, 5%, 10%	60	300	2800	0.06	600	Brown	Gray	Brown
22	100	2%, 5%, 10%	60	300	2300	0.08	600	Red	Red	Brown
27	100	2%, 5%, 10%	60	300	2000	0.08	600	Red	Violet	Brown
33	100	2%, 5%, 10%	60	300	1800	0.08	600	Orange	Orange	Brown
39	100	2%, 5%, 10%	60	300	1800	0.08	600	Orange	White	Brown
47	100	2%, 5%, 10%	60	300	1600	0.08	600	Yellow	Violet	Brown
56	100	2%, 5%, 10%	60	300	1500	0.1	600	Green	Blue	Brown
68	100	2%, 5%, 10%	60	300	1300	0.1	600	Blue	Gray	Brown
82	100	2%, 5%, 10%	60	300	1200	0.1	600	Gray	Red	Brown
91	100	2%, 5%, 10%	60	300	1100	0.1	1000	White	Brown	Brown
100	100	2%, 5%, 10%	60	300	1100	0.1	1000	Brown	Black	Red
120	50	2%, 5%, 10%	60	300	900	0.12	500	Brown	Red	Red
150	50	2%, 5%, 10%	60	300	800	0.18	500	Brown	Green	Red
180	50	2%, 5%, 10%	60	300	760	0.21	500	Brown	Gray	Red
220	50	2%, 5%, 10%	60	300	760	0.27	500	Red	Red	Red
270	50	2%, 5%, 10%	50	300	660	0.33	500	Red	Violet	Red
330	50	2%, 5%, 10%	50	100	650	0.37	500	Orange	Orange	Red
360	50	2%, 5%, 10%	50	100	500	0.63	600	Orange	Blue	Red
390	50	2%, 5%, 10%	50	100	600	0.63	500	Orange	White	Red
470	50	2%, 5%, 10%	50	100	550	0.69	400	Yellow	Violet	Red
560	50	2%, 5%, 10%	50	100	470	0.9	400	Green	Blue	Red
680	25	2%, 5%, 10%	50	100	450	1.05	400	Blue	Gray	Red
820	25	2%, 5%, 10%	50	100	400	1.45	350	Gray	Red	Red
910	25	2%, 5%, 10%	50	100	400	1.45	350	White	Brown	Red
1000	25	2%, 5%, 10%	45	100	340	2.1	280	Brown	Black	Orange
1200	7.96	2%, 5%, 10%	45	50	320	2.4	250	Brown	Red	Orange
1500	7.96	2%, 5%, 10%	45	50	300	2.7	220	Brown	Green	Orange
1800	7.96	2%, 5%, 10%	45	50	280	3.5	180	Brown	Gray	Orange
2200	7.96	2%, 5%, 10%	45	50	260	3.8	150	Red	Red	Orange
3300	27	2%, 5%, 10%	25	27	140	10	150	Orange	Orange	Orange

1812

Inductance (nH)	Inductance Tolerance	Q Min	SRF (MHz) Min	DCR (OHM) Max	Irms (mA)	COLOR CODE		
						1st	2nd	multiplier
82	2%, 5%, 10%	70	800	60	1500	Gray	Red	Black
100	2%, 5%, 10%	70	850	110	1150	Brown	Black	Brown
120	2%, 5%	70	800	110	1150	Brown	Red	Brown
150	2%, 5%, 10%	75	860	110	1150	Brown	Green	Brown
180	2%, 5%, 10%	80	850	110	1150	Brown	Gray	Brown
220	2%, 5%, 10%	80	700	105	940	Red	Red	Brown
240	5%	80	700	110	940	Red	Yellow	Brown
270	2%, 5%, 10%	85	730	120	940	Red	Violet	Brown
330	2%, 5%, 10%	80	600	135	850	Orange	Orange	Brown
390	2%, 5%, 10%	80	600	140	850	Orange	White	Brown
1200	2%, 5%, 10%	62	230	1200	480	Brown	Red	Red
3300	5%	55	145	3350	280	Orange	Orange	Red



WIRE WOUND CHIP INDUCTOR

LCWC Series

- This is a RoHS and REACH compliant product whose related document are available on request.
- Graphic is only for dimensionally application.

1. RATING TEMPERATURE

OPERATING TEMPERATURE: -40°C ~ +125°C

2. STRUCTURE

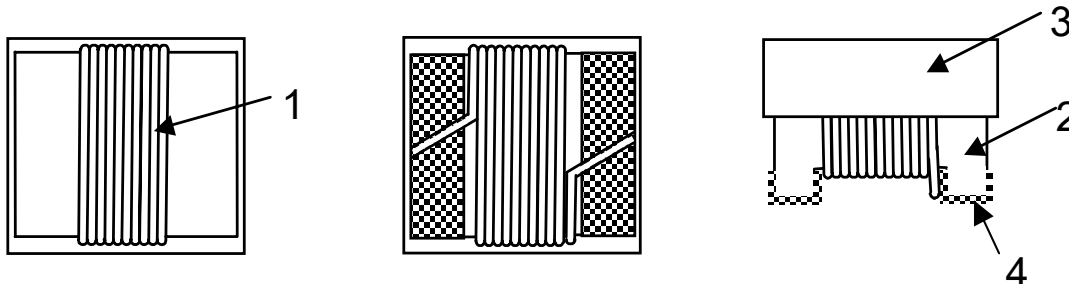

3. MATERIAL LIST

4. TEST INSTRUMENT

Item	Material Category	Material Type	UL NO.
1	Wire	Polysol	E143312
2	Core	Ceramic Core	
3	UV	UV	
4	Terminal Plateing	AgPd+Au+Ni	

	L, Q	SRF	DCR
LCWC 0402	Agilent E4991B with 16197A or its equivalent	Agilent 5071C or its equivalent	Chroma 16502 or its equivalent
LCWC 0603	Hp4291b	Hp 8753e / 5071c	Zentech 502bc
LCWC 0805	Hp4291b	Hp 8753e	Zentech 502bc
LCWC 1008	Hp4291b	Hp 8753e	Zentech 502bc
LCWC 1210	Hp4291b	Hp 8753e	Zentech 502bc
LCWC 1812	Agilent 4291B with 16193A or its equivalent	HP 8753E or HP4291B with 16193A or its equivalent	Agilent 4338b or its equivalent

WIRE WOUND CHIP INDUCTOR

LCWC Series

RELIABILITY PERFORMANCE

RELIABILITY EXPERIMENT FOR ELECTRICAL

Test Item	Test Condition	Standard Source
Humidity Test	+40°C ± 2°C, humidity of 90%±5% (total 96 hours).	MIL-STD-202G Method 103B Test Condition B
High Temperature Test	Temperature: +125°C ± 2°C. Test time: 48±2hrs.	IEC 68-2 Test Condition B
Low Temperature Test	Temperature: -40°C ± 2°C. Test time: 48±2hrs.	IEC 68-2 Test Condition A
Thermal Shock	+125°C ± 5° (30 minutes) ~ -40 ± 5°C (30 minutes), temperature switch time: 5 minutes (total 50 cycles) Wind speeds 10m/sec.	Reference MIL-STD-202G Method 107G Test Condition B-2
Life Test	+70°C ± 5°C (300Hours).	Reference MIL-STD-202G Method 108A Test Condition B

RELIABILITY EXPERIMENT FOR PHYSICAL

Test Item	Test Condition	Standard Source
Vibration Test	10-55-10HZ, amplitude: 1.5mm, direction: X, Y, Z axes, each axis 2 hours (total 6 hours).	MIL-STD-202G Method 201A
Solder Heat Resistance Test	IR/convection reflow: Peak Temp 255°C~260°C for 3~5 Sec. in air, Through 2 Cycle. Temperature Ramp:+1~4°C/sec.; Above 217°C, must keep 90 s - 120 s.	Reference MIL-STD-202G Method 210F Test Condition K (Reflow)
Solder Ability Test	Soak in 245°C solder pot of 3~5 Sec., PAD must have 95% above coverage.	Reference J-STD-002D

TYPICAL ROHS REFLOW PROFILE

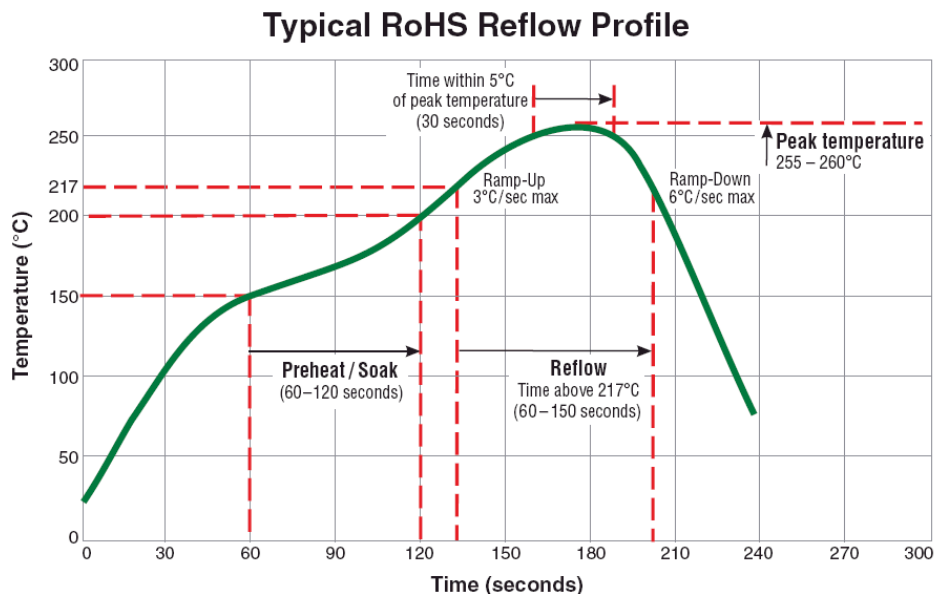

WIRE WOUND CHIP INDUCTOR

LCWC Series



ENVIRONMENTAL CHARACTERISTICS

MECHANICAL PERFORMANCE TEST

Items	Requirement	Test Methods
Inductance	Refer to standard electrical characteristic spec.	HP4286
Q		HP4286
SRF		HP4287
DC Resistance RDC		Micro-Ohm meter (Gom-801G)
Rated Current IDC		Applied the current to coils, The inductance change should be less than 10% to initial value
Over Load	Inductors shall have no evidence of electrical and mechanical damage	Applied 2 times of rated allowed DC current to inductor for a period of 5 minutes
Withstanding Voltage	Inductors shall be no evidence of electrical and mechanical damage.	AC voltage of 500 VAC applied between inductors terminal and case for 1 min.
Insulation Resistance	1000M ohm min.	100 VDC applied between inductor terminal and case and case

MECHANICAL PERFORMANCE TEST

Items	Requirement	Test Methods
Vibration	Appearance: No damage L change: within $\pm 5\%$ Q change: within $\pm 10\%$	Test device shall be soldered on the substrate Oscillation Frequency: 10 to 55 to 10Hz for 1 min. Amplitude: 1.5 mm Time: 2 hrs for each axis (X, Y & Z), total 6 hrs
Resistance to Soldering Heat		Solder Temperature: $260 \pm 50^\circ\text{C}$ Immersion Time: 10 ± 2 seconds
Component Adhesion (Push Test)	1 lbs. For 0402 2 lbs. For 0603 3 lbs. For the rest	The device should be soldered (260 ± 5 for 10 seconds) to a tinned copper subs rate. A dynamiter force gauge should be applied to the side of the component. The device must with stand a minimum force of 2 or 4 pounds without a failure of adhesion on termination
Drop	No damage	Dropping chip by each side and each corner. Drop 10 times in total Drop height: 100 cm Drop weight: 125 g
Solderability	90% covered with solder	Inductor shall be dipped in a melted solder bath at 245 ± 5 for 3 seconds
Resistance to Solvent	No damage on appearance and marking	MIL-STD202F, Method 215D

CLIMATIC TEST

Items	Requirement	Test Methods															
Temperature Characteristic	Appearance: No damage L change: within $\pm 10\%$ Q change: within $\pm 20\%$	$-40 \sim +125^\circ\text{C}$															
Humidity		Temperature: $40 \pm 2^\circ\text{C}$ Relative Humidity: 90 ~ 95% Time: 96 ± 2 hrs Measured after exposure in the room condition for 2 hrs															
Low Temperature Storage		Temperature: $-40 \pm 2^\circ\text{C}$ Time: 96 ± 2 hrs Inductors are tested after 1 hour at room temperature															
Thermal Shock		One cycle: <table border="1" style="margin-left: 20px;"> <thead> <tr> <th>Step</th> <th>Temperature ($^\circ\text{C}$)</th> <th>Time (min.)</th> </tr> </thead> <tbody> <tr> <td>1</td> <td>-25 ± 3</td> <td>30</td> </tr> <tr> <td>2</td> <td>25 ± 2</td> <td>15</td> </tr> <tr> <td>3</td> <td>125 ± 3</td> <td>30</td> </tr> <tr> <td>4</td> <td>25 ± 2</td> <td>15</td> </tr> </tbody> </table>	Step	Temperature ($^\circ\text{C}$)	Time (min.)	1	-25 ± 3	30	2	25 ± 2	15	3	125 ± 3	30	4	25 ± 2	15
Step		Temperature ($^\circ\text{C}$)	Time (min.)														
1		-25 ± 3	30														
2		25 ± 2	15														
3	125 ± 3	30															
4	25 ± 2	15															
High Temperature Storage	Temperature: $125 \pm 2^\circ\text{C}$ Time: 96 ± 2 hrs Measured after exposure in the room condition for 1 hour																
High Temperature Load Life	Temperature: $85 \pm 2^\circ\text{C}$ Time: 1000 ± 12 hrs Load: Allowed DC current																
Damp Heat with Load	Temperature: $40 \pm 2^\circ\text{C}$ Relative Humidity: 90 ~ 95% Time: 1000 ± 12 hrs Load: Allowed DC current																

WIRE WOUND CHIP INDUCTOR

LCWC Series

LCWC 0402 PAPER TAPE PACKAGING

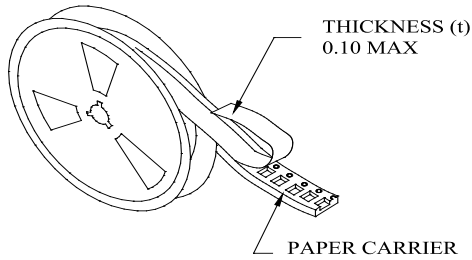

- THE FORCE FOR TEARING OFF COVER TAPE IS 10 TO 100 GRAMS IN THE ARROW DIRECTION.

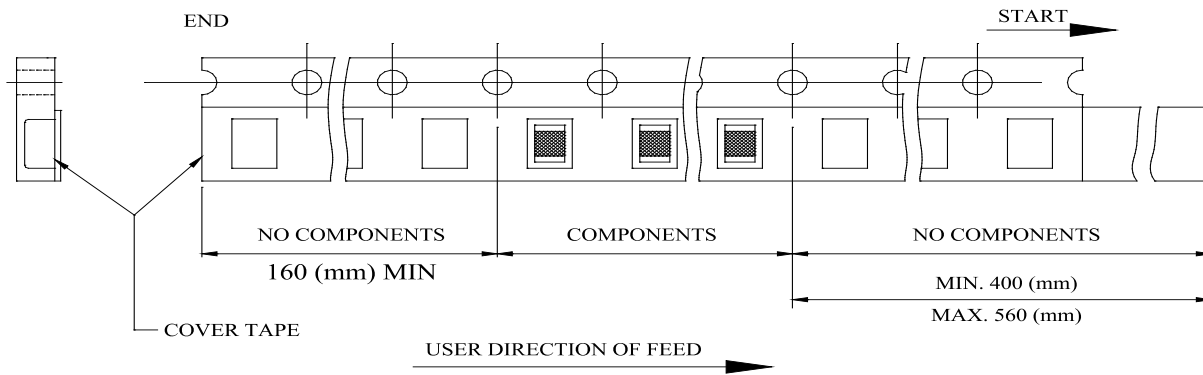
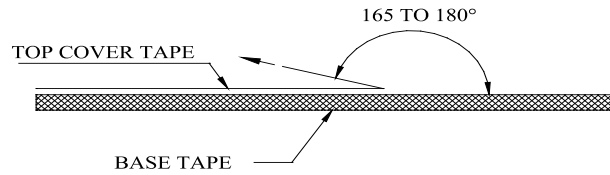

CARRIER TAPE REELS (mm)

MATERIAL: PAPER

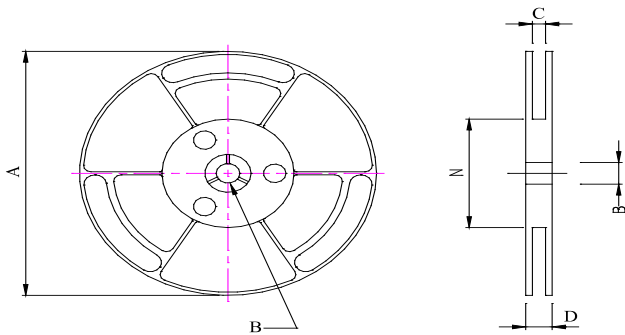

DIMENSIONS OF CARRIER TAPE (mm)

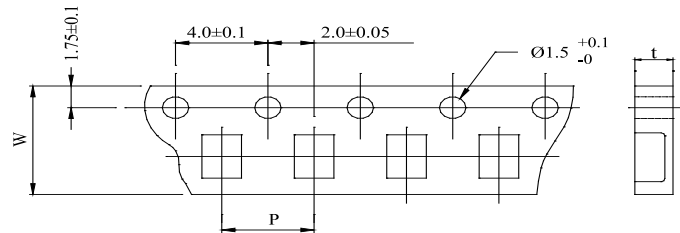

PAPER TAPE (mm)

Series	A	B	C	D	N	P	W	t	Reel(EA)
LCWC 0402	178Max	13.0±0.5-0.2	8.4±0.2-0	14.4Max	50Min	2.0 ±0.1	8.0 ±0.2	0.68 ±0.03	4,000

WIRE WOUND CHIP INDUCTOR

LCWC Series

LCWC 0603 EMBOSSED TAPE PACKAGING

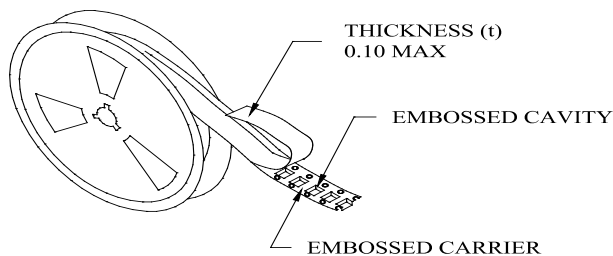

- THE FORCE FOR TEARING OFF COVER TAPE IS 10 TO 100 GRAMS IN THE ARROW DIRECTION.

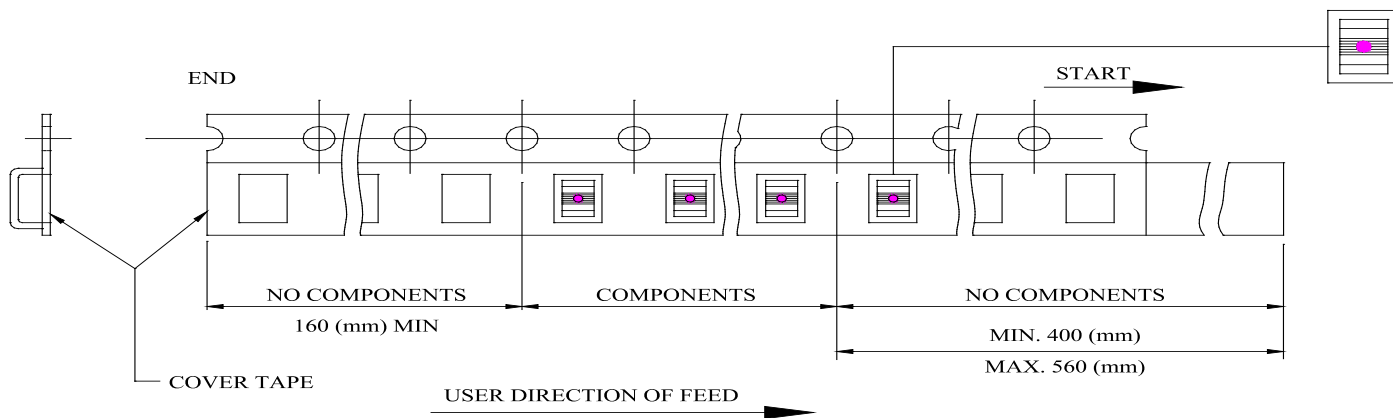
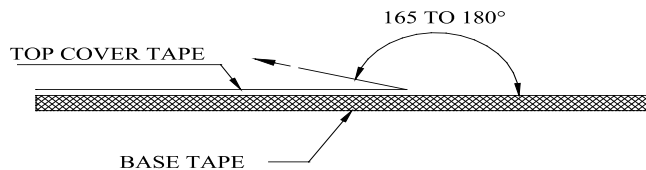

CARRIER TAPE REELS (mm)

MATERIAL: PLASTIC

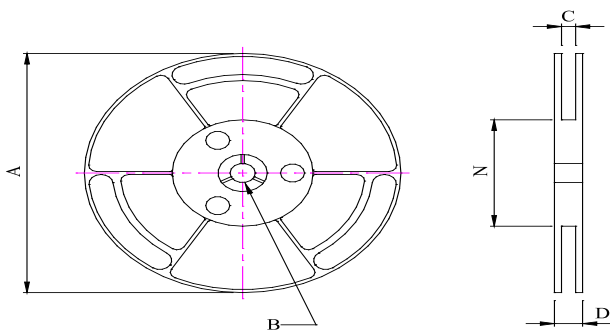

DIMENSIONS OF CARRIER TAPE (mm)

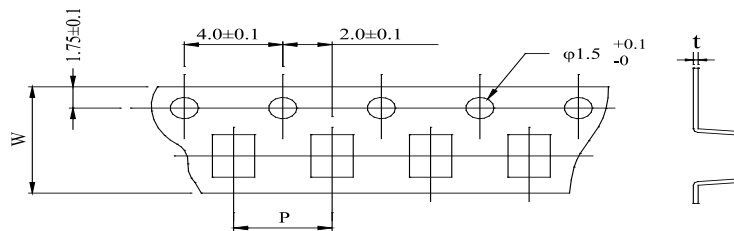

PLASTIC TAPE (mm)

Series	A	B	C	D	N	P	W	t	Reel(EA)
LCWC 0603	180Max	13.0 ±0.8	8.4+1.0-0	12.5Max	50Min	4.0 ±0.1	8.0 ±0.2	0.25 ±0.05	4,000
LCWC 0805	178±2.0	13.0 ±0.8	8.4+1.0-0	12.5Max	50Min	4.0 ±0.1	8.0 ±0.2	0.25 ±0.05	3,000
LCWC 1008	178±0.2	13.0 ±0.8	8.4+1.0-0	12.5Max	50Min	4.0 ±0.1	8.0 ±0.2	0.25 ±0.05	2,000
LCWC 1210	178±2.0	13.0 ±0.8	8.4+1.0-0	12.5Max	50Min	4.0 ±0.1	8.0 ±0.2	0.23 ±0.05	1,500
LCWC 1812	178Max	13.0+0.5-0.2	12.5+1.5-0	16.4+1.5-0	50Min	8.0 ±0.1	12.0 ±0.2	0.23 ±0.05	600