

CHIP INDUCTORS

LCCM Series – Chip Common Mode Filter



FEATURES

- Small wire wound chip inductor with ferrite core and 2 common mode lines.
- Highly effective in noise suppression
- High common-mode impedance at noise band and low differential mode impedance at signal band factor. There is almost no distortion in high-speed signals.
- Operating temperature -40°C ~ 85°C.

APPLICATIONS

- EMI suppression for electronic devices.
- USB line in personal computers and peripherals.
- IEEE 1394 line for personal computers, DVC, and STB
- LCD Panels.
- Low-Voltage Differential Signal (LVDS)

CONSTRUCTION

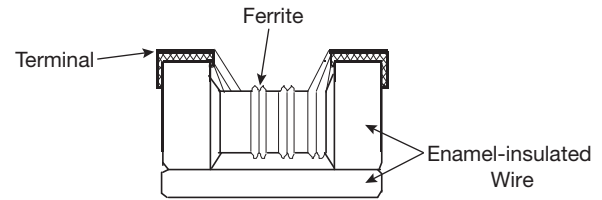

DIMENSIONS

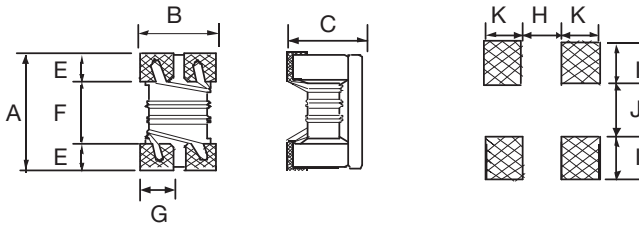

mm (inches)

Type	Size (inch)	A	B	C	E	F	G	H	I	J	K	Weight (g) (1000pcs)
LCCM0805	0805	2.00 ± 0.20 (0.079 ± 0.008)	1.20 ± 0.20 (0.047 ± 0.008)	1.20 ± 0.20 (0.047 ± 0.008)	0.45 (0.018)	1.20 (0.047)	0.40 (0.016)	0.80 (0.031)	0.40 (0.016)	0.40 (0.016)	0.90 (0.035)	19
LCCM1206	1206	3.20 ± 0.20 (0.126 ± 0.008)	1.60 ± 0.20 (0.063 ± 0.008)	1.80 ± 0.20 (0.071 ± 0.008)	0.60 (0.024)	2.00 (0.079)	0.60 (0.024)	1.60 (0.063)	0.60 (0.024)	0.40 (0.016)	1.05 (0.041)	53.3

HOW TO ORDER

LC	CM	0805	M	101	G	T	A	R
Family	Series	Size	Tolerance	Impedance	Style	Termination	Special	Packaging
LC = Chip Inductor	CM = Common Mode	0805 1206	M = 20%	670 = 67 Ω 371 = 370 Ω 102 = 1000 Ω 222 = 2200 Ω	G = Standard	T = Sn Plating	A = Standard	R = 7" Reel

CHIP INDUCTORS

LCCM Series – Chip Common Mode Filter



ELECTRICAL CHARACTERISTICS

0805

Impedance (Ω)	Tolerance	Test Condition (MHz)	DCR (Ω) max.	IDC (mA) max.	Rated Voltage Vdc (V)	Withstanding Voltage Vdc (V)	Insulation Resistance (MΩ) min.
67	±20%	100	0.25	400	50	125	10
75	±20%	100	0.30	400	50	125	10
90	±20%	100	0.35	330	50	125	10
100	±20%	100	0.35	330	50	125	10
120	±20%	100	0.30	370	50	125	10
160	±20%	100	0.35	350	50	125	10
180	±20%	100	0.35	330	50	125	10
200	±20%	100	0.35	300	50	125	10
220	±20%	100	0.40	300	50	125	10
260	±20%	100	0.40	300	50	125	10
360	±20%	100	0.50	300	50	125	10
370	±20%	100	0.45	280	50	125	10
430	±20%	100	0.55	280	50	125	10
600	±20%	100	0.60	240	50	125	10
750	±20%	100	0.90	220	50	125	10

1206

Impedance (Ω)	Tolerance	Test Condition (MHz)	DCR (Ω) max.	IDC (mA) max.	Rated Voltage Vdc (V)	Withstanding Voltage Vdc (V)	Insulation Resistance (MΩ) min.
90	±20%	100	0.30	400	50	125	10
160	±20%	100	0.40	340	50	125	10
260	±20%	100	0.50	310	50	125	10
600	±20%	100	0.80	260	50	125	10
1000	±20%	100	1.00	230	50	125	10
2200	±20%	100	1.20	200	50	125	10

LCCM0805 CHARACTERISTICS – IMPEDANCE VS. FREQUENCY

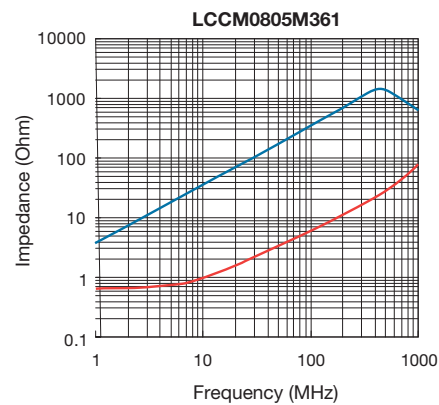
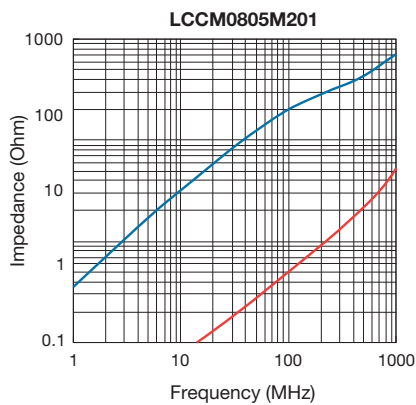
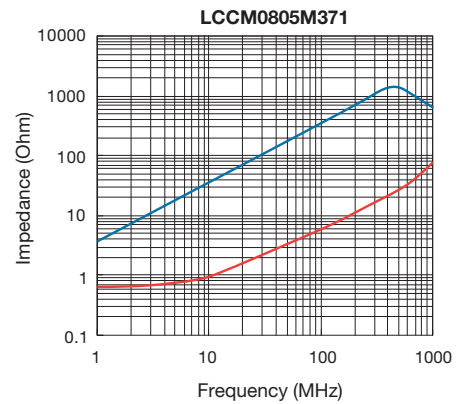
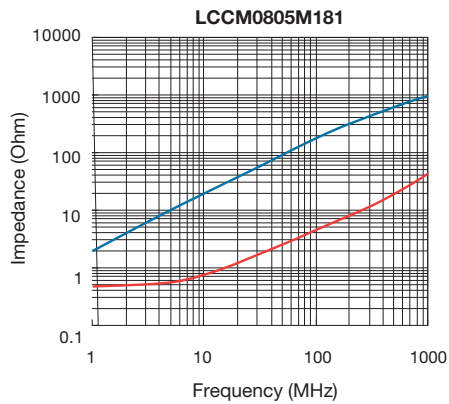
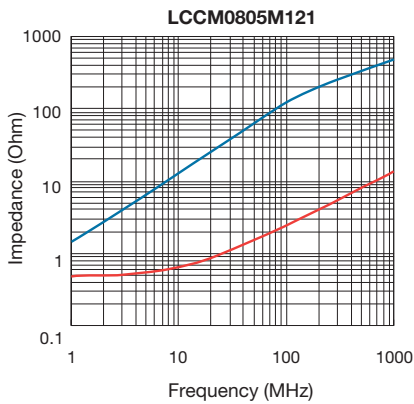
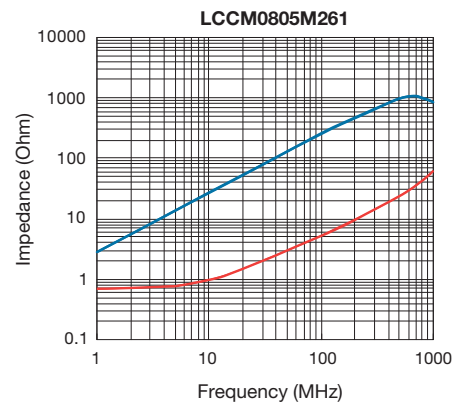
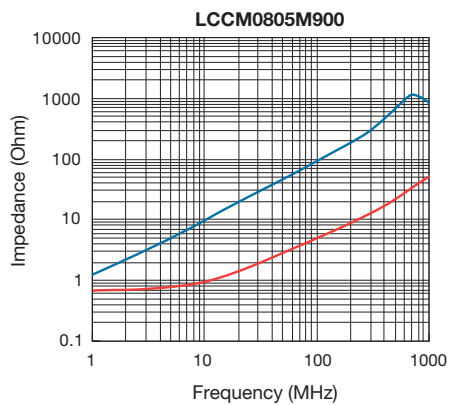
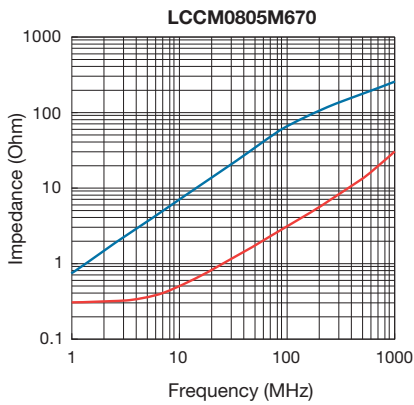

— Common Mode — Differential Mode

LCCM1206 CHARACTERISTICS – IMPEDANCE VS. FREQUENCY

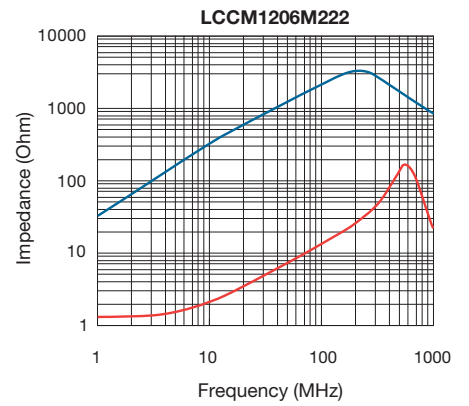
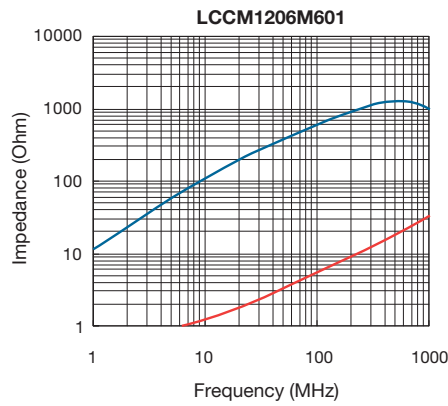
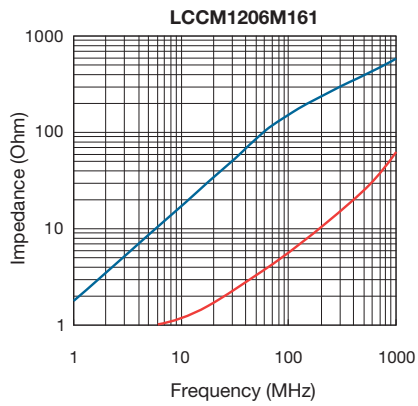
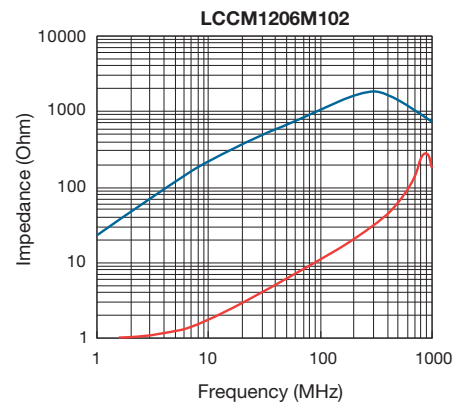
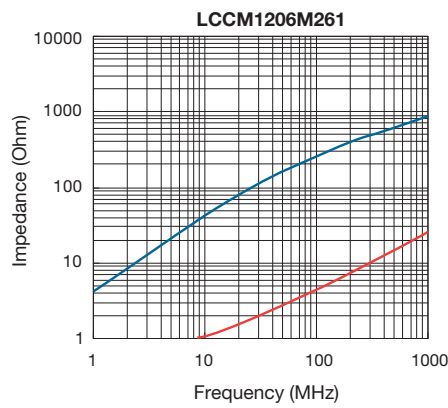
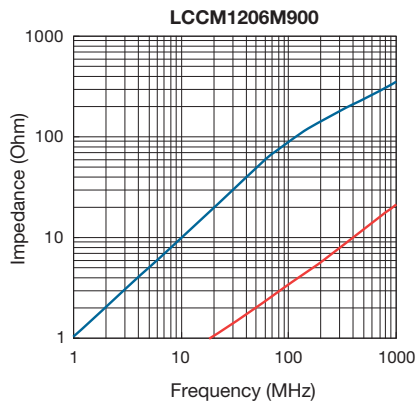

— Common Mode — Differential Mode

ENVIRONMENTAL CHARACTERISTICS

ELECTRICAL PERFORMANCE TEST

Items	Requirement	Test Conditions Test Methods
Impedance	Refer to standard electrical characteristic spec. Component should not be damaged	LCR Meter HP 4291B
DC Resistance DCR		Micro-Ohm meter (GOM-801G)
Withstand Voltage (VDC)		Test Voltage: 2.5 Times Rated Voltage Testing Time: 60 seconds Charge Current: 0.5mA
Rated Voltage (VDC)		Test Voltage: Rated Voltage Testing Time: 1 to 5 seconds Charge Current: 1mA
Insulation Resistance (I.R)		Charge Current: 1minute 10M ohm min.

MECHANICAL PERFORMANCE TEST

Items	Requirement	Test Conditions Test Methods
Component Adhesion (Push Test)	Base: 0805 2 Lbs Cover: 0805 1 Lbs Base: 1206 4 Lbs Cover: 1206 2 Lbs	The component should be soldered (232°C ± 5°C for 10 sec.) to tinned copper substrate Applied force gauge to the side of component It must withstand force of 2 or 4 pounds without failure of the component.
Drop	Component should not be damaged	Dropping chip by each side and corner. Drop 10 times in total Drop height: 100 cm Drop weight: 125 g
Solderability	The terminal should at least be 90% covered with solder	The component shall be dipped in a melted solder bath at 245 ± 5°C for 3 seconds
Vibration Test (Low Frequency)	Component should not be damaged	1. Amplitude: 1.5 m/m 2. Frequency: 10-55-10Hz (1min.) 3. Direction: X, Y, Z 4. Duration: 2 Hrs/X, Y, Z

MECHANICAL PERFORMANCE TEST

Items	Requirement	Test Conditions Test Methods
Low Temperature Storage	Impedance change: Within ± 20% Without distinct damage in appearance	1. Temp: -40 ± 2°C 2. Time: 1000 ± 48 Hours 3. Component should be tested after 1 hour at room temperature
Thermal Shock		 <p>Total: 5 Cycles</p>
High Temperature Storage		1. Temp: 85 ± 2°C 2. Time: 1000 ± 48 Hours 3. Component should be tested after 1 hour at room temperature
Humidity		1. Temp: 40 ± 2°C 2. R.H. : 90 - 95% 3. Time: 48 ± 2 Hours
High Temperature Load Life		1. Temp: 85 ± 2°C 2. Time: 96 ± 12 Hours 3. Load: Allowed DC Current
Low Temperature Load Life	There should be no evidence of short or open circuit	1. Temp: -40 ± 2°C 2. Time: 96 ± 12 Hours 3. Load: Allowed DC Current

PACKAGING QUANTITY REAL SPECIFICATIONS

Type	Embossed Plastic Tape (EA)
LCCM0805	2,000
LCCM1206	2,000

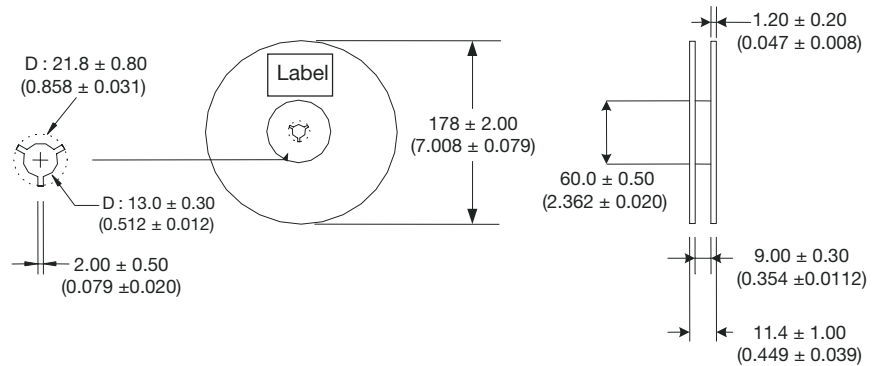

EMBOSSED PLASTIC TAPE SPECIFICATIONS

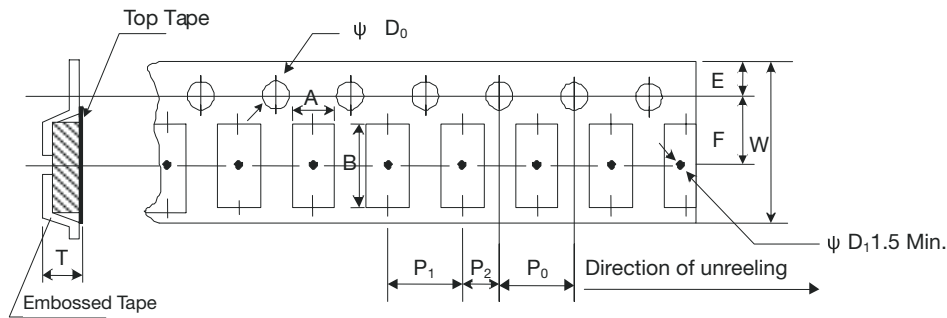

Type	A	B	W	E	F	P ₀	P ₁	P ₂	ΦD ₀	T
LCCM0805	1.40 ± 0.10 (0.055 ± 0.004)	2.55 ± 0.05 (0.100 ± 0.002)	8.0 ± 0.20 (0.315 ± 0.008)	1.75 ± 0.10 (0.069 ± 0.004)	3.50 ± 0.10 (0.138 ± 0.004)	4.00 ± 0.10 (0.157 ± 0.004)	4.00 ± 0.10 (0.157 ± 0.004)	2.00 ± 0.10 (0.079 ± 0.004)	1.50 ± 0.10 (0.059 ± 0.004)	1.35 ± 0.10 (0.053 ± 0.004)
LCCM1206	1.90 ± 0.10 (0.075 ± 0.004)	3.50 ± 0.05 (0.138 ± 0.004)	8.0 ± 0.20 (0.315 ± 0.008)	1.75 ± 0.10 (0.069 ± 0.004)	3.5 ± 0.10 (0.138 ± 0.004)	4.00 ± 0.10 (0.157 ± 0.004)	4.00 ± 0.10 (0.157 ± 0.004)	2.00 ± 0.10 (0.079 ± 0.004)	1.50 ± 0.10 (0.059 ± 0.004)	2.10 ± 0.10 (0.083 ± 0.004)

mm (inches)

LEADER/TAPE

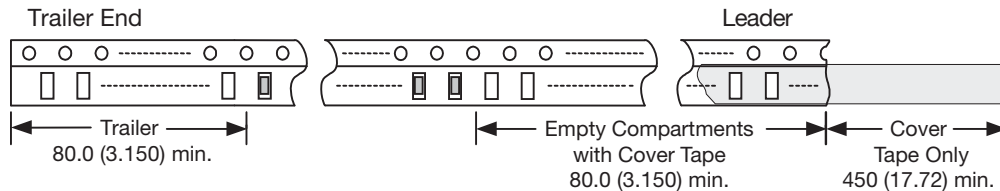

PEEL-OFF FORCE

The force for tearing off cover tape is 0.05 - 0.69 (N) in the arrow direction at the following conditions:

- Temperature: 5 - 35°C
- Humidity: 45 - 85%
- Atmospheric pressure: 860 - 1060hpa

